

VALVES CONTROLS ACCESSORIES



Take
a Good Look
It May Be Your Future



SIL 3

TA-LUFT

API 607

ISO 9001

Mars Direct Mount Ball Valve Sets A New Standard For Ball Valve / Actuator Mounting, Enhances Functional Performance With Easy Installation And Lower Maintenance Cost.



The new way of mounting actuator is the Direct Mount Configuration, it is designed to overcome the problems of conventional actuator mounting. This design allows an actuator bolted directly to the top of ball valves for greater reliability, easy installation and improved cycling life.

No bracket and adapter are required, the valve stem is an integral part of the actuator drive. The direct valve stem coupling to actuator shaft ensures correct alignment of the valve to the actuator, minimizes stem side loading and backlash during operation, increased service life and performance.

- **Modular design and simplicity**

No confusion as to how to select brackets and adapters.

- **Low cost and easy automation**

Direct mount eliminates the need for additional brackets and adapters, time and labor saving too.

In the event maintenance is needed, Mars Direct Mount ball valves facilitate fast, easy breakdown and assembly of ball valve and actuator package, the result is reduced maintenance time and the lowest overall cost of ownership.

- **Compact and Space-Saving**

The close coupling of the actuator to the valve makes the total package as compact as possible.

- **Safety**

There are no External Moving Parts, No Pinch Points.

- **Direct Valve Stem / Actuator Drive Connection**

Less chance for Hysteresis.



MARS DIRECT MOUNT BALL VALVES MAKING OTHERS FOLLOWERS

Mars Patented Direct Mount Ball Valves can be easily, best of all, mated to pneumatic and electric actuators with no brackets and couplings to produce the total final control elements, and in combination with our Maintenance Free, Triple Sealing, High Cycle Stem Packing System, Mars Direct Mount Ball Valve is your best choice for automation service.



SERIES 22



SERIES 77



SERIES 77L



**SERIES 88
SERIES 88X**



**Mars Valve
Not Only Offers You
Cost Effective
High Quality Ball Valves
But
Also Offers You
A Successful Future**



**SERIES 90D
SERIES 90DX**



SERIES 91D



SERIES 94D



SERIES 33



SERIES 36



**SERIES 39
SERIES 39M**



SERIES 99



SERIES 77SN



SERIES 88SN



SERIES 33SN



SERIES 39SN

MARS UNIQUE SEALMAX® STEM DESIGN - MAINTENANCE FREE - TRIPLE SEALING SYSTEM - LIVE LOADED STEM PACKING - EXTREMELY HIGHT CYCLE - PROVIDES OPTIMUM STEM SEALS

1. PYRAMIDAL STEM WITH STEM SEAL

First stage of defense against leakage. The 45 degree slope of the stem accompany the stem seal effectively blocks all leak path during rotation.

2. O-RING STEM PACKING

Second stage of defense against leakage, enhances stem seal and maintains stem alignment, provides extra longer service life.

3. V-RING STEM PACKING

Third stage of defense against leakage. multiple layers of V-Ring Chevron Packing expands side way as it is being compressed, blocking all air pockets to prevent leak path.

4. LOCK SADDLE

Stabilizes the entire stem nut to keep it from loosening during operation.

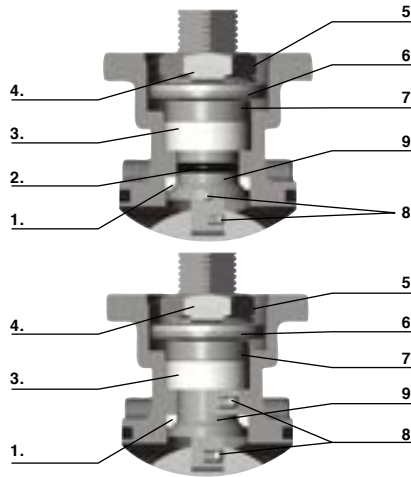

5. STEM NUT

Compress the entire stem system to enable blocking of leakage.

6. BELLEVILLE WASHERS

Automatically compress the seals to adjust for wear, pressure, and temperature fluctuations.

7. GLAND

Made of stainless steel, equally distributes the compressive force on the packing and seal.

8. ANTI-STATIC DEVICE

Spring loaded stem-to-ball and stem-to-body anti-static device as standard

9. SUPER SMOOTH STEM FINISH

Reduces seal friction and operating torque, prolongs service life.

MARS BALL VALVE SEAT APPLICATION GUIDE

Mars valve offers a wide choice of soft seats and metal seats for variety of industry applications, all of the following applications should be used in conjunction with the pressure temperature graph and the corrosion chart.

PTFE(P)

Made from Virgin Teflon, this is the most common sealing material, its chemical compatibility is excellent for almost all media. Temperature-50°F to 400°F, Color - White. PTFE Cavity Filled Seats Available on request(PF)

R-PTFE(R)

15% glass reinforced PTFE, suitable for Temperature - 50°F to 450°F, chemical resistance is compatible to virgin PTFE with better wear factor. Color - Off White.

Carbon filled PTFE(C)

25% Carbon powder with 75% PTFE, this material offers a wide temperature range with good wear resistance than RTFE. Suitable for steam service. Temperature - 50°F to 450°F. Color - Black.

Stainless Steel filled PTFE(S)

50% stainless steel powder filled 50% PTFE, offers abrasion resistance of metal with higher pressure and temperature than RTFE. Temperature - 50°F to 470°F. Color - Dark Grey.

PFA-TFM1600(T)

The new generation of PTFE, offers better creep resistance, low coefficient of friction, ideal for semi-conductor, Hi-purity service.

MG1241(M)

75% PTFE + 20% Glass Fiber + 5% Graphite, good for temperature from - 50°F to 450°F, this material offers a wide temperature range with better life than R-PTFE. Color - Pale Black.

DELRIN(D)

This material is very rigid, suitable for high pressure up to 5000 psi dependent on valve size and temperature range of - 50°F to 180°F. Color - Creamy White.

PEEK(K)

Best suited for high temperature and pressure service, suitable for tobacco and nuclear service. Temperature ration - 70°F to 550°F. Color - Black

UHMW Polyethylene(U)

Ultra-high molecular weight polyethylene, ideal for use in low level radiation service, this material also meets the requirements of the Tobacco industry where PTFE is prohibited and it offers an excellent resistance to abrasive media. Temperature rating-70°F to 200°F. Color - Opaque White.

Metal Seats(A)

For service with severe flashing or hydraulic sock, abrasive media

API 607 6th EDITION FIRE-TESTED BALL VALVES



Mars Series 83, Series 88, Series 90, Series 90D, and Series 91D have been awarded Fire-Safe Certificates by SwRI (Southwest Research Institute, TX, USA) and TUV Germany. The API 607 6th Edition is the latest, most severe test, reflecting the conditions of a fire in the field. Passed this test gives us and our customers a tremendous advantage in the Oil and Gas, Refining and Chemical Industries.



SERIES 28
1/4" - 3" *



SERIES 90
SERIES 90X
1/2" - 4"



SERIES 90D
1/2" - 12" *
SERIES 90DX
1/2" - 12" *



SERIES 91D
1/2" - 6" *



SERIES 96D
SERIES 96DX
1/2" - 4"



SERIES 83
1/4" - 2"



SERIES 88
SERIES 88X
1/4" - 4"

HIGH PERFORMANCE THREE-PIECE BALL VALVE



SERIES 88

- Direct Mount
 - Fire Safe Certified
 - Full & Reduced Port
 - NACE MR - 0175 on request
- Size: 1/4"-4"
Rating: 2000 PSI max.
Body: CF8M/WCB
Ball: 316 S/S / CF8M
Stem: SS316 / 17-4 PH
Seats: R-TFE
Ends: *TH, SW, BW, FL, XBW, XOW



SERIES 83

- Fire Safe Certified
 - Full & Reduced Port
- NACE MR - 0175 on request
Size: 1/4"-2"
Rating: 2000 PSI max.
Body: CF8M/WCB
Ball: 316 S/S / CF8M
Stem: SS316 / 17-4 PH
Seats: R-TFE
Ends: *TH, SW, BW, FL, XBW, XOW



SERIES 77

- Direct Mount
 - Full Port
 - Face to Face DIN 3202 M3 on request
 - NACE MR - 0175 on request
- Size: 1/4"-4"
Rating: 1000 PSI max.
Body: CF8M/WCB
Ball: 316 S/S / CF8M
Stem: SS316 / 17-4PH
Seats: R-TFE
Ends: *TH, SW, BW, FL, XBW, XOW

* AVAILABLE ENDS: TH-THREADED / SW-SOCKET WELD / BW-BUTT WELD / FL-FLANGED / XBW-EXTENDED BUTT WELD / XOW-EXTENDED ORBITAL WELDING (ISO)

* ALL STAINLESS STEEL WELDING ENDS STANDARD IN 316L S/S

BALL VALVE 6000 PSI

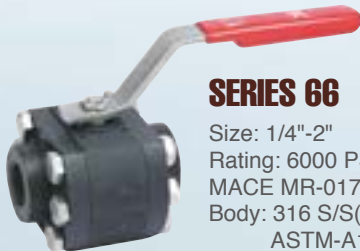

SERIES 66

- Size: 1/4"-2"
Rating: 6000 PSI
MACE MR-0175
Body: 316 S/S (bar stock) / ASTM-A105
Stem: 17-4PH
Seats: PEEK / DELRIN
Ends: TH, SW, BW



SERIES 29

- Full Port or Reduced Port 1/4" - 2", 6000 PSI
- Seal welded design for zero leakage
 - Design standard to ASME B16.34 Class 2500
 - Blow-out proof stem
 - Delrin seats standard
 - Fire safe design in compliance with API 607 and BS6755
 - ISO 5211 mounting pad for easy automation
 - Material specifications conform to NACE standard MR-0175
 - Available Ends: Threaded (Female/Female, Male/Female), and Socket Weld

HIGH PERFORMANCE TWO-PIECE BALL VALVES



SERIES 22

Direct Mount Design
 Full Port
 Size: 1/4" - 3"
 Rating: 1000 PSI max
 Body: CF8M / WCB
 Ball: 316 S.S. / CF8M
 Stem: 316 S.S.
 Seats: R-TFE
 Ends: NPT, BSP, BSPT



SERIES 20-50

ISO 5211 MOUNTING PAD
 Full Port
 Size: 1/4" - 3"
 Rating: 1000 PSI max
 Body: CF8M / WCB
 Ball: 316 S.S. / CF8M
 Stem: 316 S.S.
 Seats: R-TFE
 Ends: NPT, BSP, BSPT



SERIES 24

Direct Mount Design
 1/4"-1 1/2" Full Port
 2" Reduced Port
 Size: 1/4" - 2"
 Rating: **3000 PSI**
 Body: CF8M / WCB
 Ball / Stem: 316 S.S.
 Seats: Delrin / PEEK / Nylon
 Ends: **Female / Female,**
Male / Female
 NPT, BSP, BSPT



SERIES 28

Seal Welded
API 607 5th Edition-CF8M
API 607 6th Edition-WCB
 Full Port
 Size: 1/4" - 3"
 Rating: 2000 PSI
 Body: CF8M / WCB
 Ball: 316 S.S./CF8M
 Stem: 316 S.S.
 Seats: 25%Carbon +75%PTFE
 Ends: NPT, BSP, BSPT

★ NACE MR - O175 on request

ECONOMICAL TWO-PIECE BALL VALVES

Stainless Steel and Carbon Steel, End Connections: NPT, BSP, BSPT



FIG 20-10

1/4" - 2" / 1000 PSI
 Full Port



FIG 20-20

1/8" - 4" / 1000 PSI
 Full Port



FIG 20-30

1/4" - 2" / 1500 / 2000 PSI
 Reduced Port



FIG 20-40

1/4" - 2" / 1500 / 2000 PSI
 Full Port

ECONOMICAL THREE-PIECE BALL VALVES

1/4" - 4" Stainless Steel and Carbon Steel, Full Port, 1000 PSI max.

Available Ends: Th-Threaded / Sw-Socket Weld / Bw-Butt Weld / FL-Flanged / Xbw-Extended Butt Weld / Xow - Extended Orbital Weld(ISO)



SERIES 50

- Gland Stem Packing



SERIES 55A

- ISO 5211 Mounting Pad
- Gland Stem Packing



SERIES 55

- Machined face ISO 5211 Mounting Pad
- Live Loading Stem Packing



SERIES 78

- Direct Mount Design
- Live Loading Stem Packing

ECONOMICAL ONE-PIECE BALL VALVES



FIG 10-10

Size: 1/4" - 2"
 Rating: 800 PSI
 Reduced Port
 Body: CF8M
 Ball / Stem: 316 S/S
 Seats: PTFE
 Ends: NPT, BSP, BSPT



FIG 10-20

Size: 1/4" - 2"
 Rating: 1000 PSI
 Reduced Port
 Body: CF8M
 Ball / Stem: 316 S/S
 Seats: PTFE
 Ends: NPT, BSP, BSPT



FIG 10-30

Size: 1/4" - 1"
 Rating: 800 PSI
 Reduced Port
 Body: CF8M
 Ball / Stem: 316 S/S
 Seats: PTFE
 Ends: NPT, BSP, BSPT



FIG 10-40

Mini-Ball Valve
 Size: 1/8" - 1/2"
 Rating: 800 PSI
 Reduced Port
 Body: CF8M
 Ball / Stem: 316 S/S
 Seats: PTFE
 Ends: NPT, BSP, BSPT



FIG 10-50

Mini-Ball Valve
 Size: 1/8" - 1/2"
 Rating: 800 PSI
 Reduced Port
 Body: CF8M
 Ball / Stem: 316 S/S
 Seats: PTFE
 Ends: NPT, BSP, BSPT



NON RETURN THREE-PIECE BALL CHECK VALVES

Designed for handling steam and aggressive media

One valve instead of an isolation valve and a non-return valve for most steam and process applications, space saving, light weight and low cost of installation

Size: 1/4" - 4"

Pressure rating: 1000 PSI

Body material: ASTM A351 CF8M

Seat material: Carbon filled PTFE, 50/50 S.S. filled PTFE

End options: Threaded, Socket Weld, Butt Weld,
Tube (OD) Butt Weld, Flanged

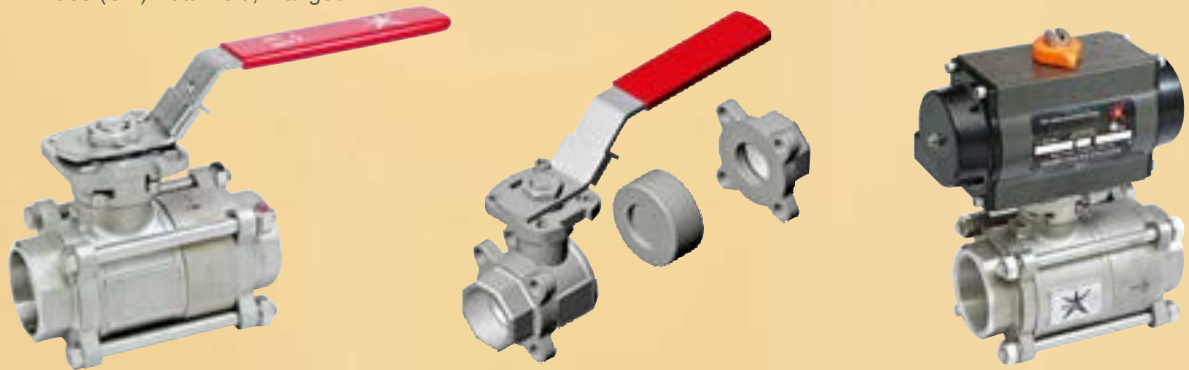

SAMPLING VALVE

Sample process media quickly and easily with Mars Sampling Valve.

- Special cylindrical pad design to be welded flush with the I.D. of a tube, pipe, or vessel to minimize dead space.

- Manual or Automated

Size: 1" - 4"

Materials:

- CF8M & CF3M

- Duplex
- Titanium
- Monel
- Alloy 20
- Hastelloy C

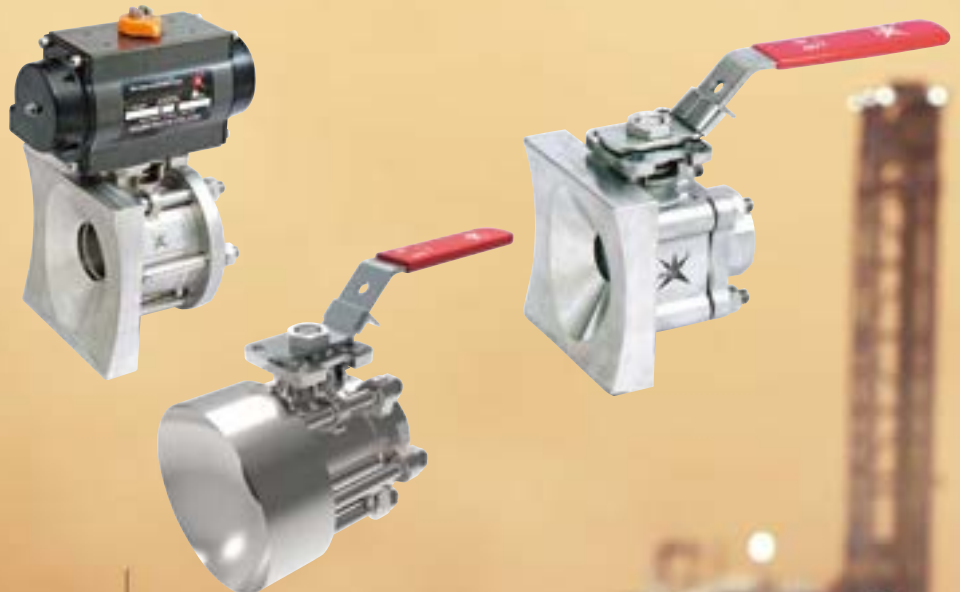

MARS HIGH PERFORMANCE FLANGED BALL VALVES



SERIES 90 ANSI CLASS 150, PN16/40

Fire Safe Tested to API 607 4th & 6th Edition
 Size: 1/2" - 4" Full Port
 Body : CF8M/WCB, 1.4408/1.0619
 Ball : CF8M / 1.4408
 Stem : 316 S.S. / 17-4 PH
 Seats: PTFE, RTFE, TFM1600
 Face to Face: ANSI B16.10
 EN 558-1, GR.1/GR.27
 (DIN 3202-F1, F4/F5)

- NACE MR - 0175 On Request



SERIES 90X Double Body Gasket Design ANSI CLASS 150, PN16/40

Fire Safe Tested to API 607 6th Edition
 Size : 1/2" - 4" Full Port
 Body : CF8M/WCB, 1.4408/1.0619
 Ball : CF8M / 1.4408
 Stem : 316 S.S./17-4 PH
 Seats : PTFE, RTFE, TFM1600
 Face to Face : ANSI B16.10
 EN558-1, GR.1/GR.27
 (DIN3202-F1,F4/F5)

- NACE MR-0175 On Request



SERIES 90D ANSI CLASS 150, 300, PN16/40

Direct Mount Design
 Fire Safe Tested to API 607 4th & 6th Edition
 Size: 1/2" - 12" Full Port
 Body : CF8M / WCB, 1.4408 / 1.0619
 Ball : CF8M / 1.4408
 Stem : 316 S.S. / 17-4 PH
 Seats: PTFE, RTFE, TFM1600
 Face to Face: ANSI B16.10
 EN 558-1,GR.1/GR.27
 (DIN 3202-F1, F4/F5)

- NACE MR - 0175 On Request



SERIES 90DX Double Body Gasket Design ANSI CLASS 150, 300, PN16/40

Direct Mount Design
 Fire Safe Tested to API 607 6th Edition
 Size : 1/2" - 12" Full Port
 Body : CF8M/WCB, 1.4408 / 1.0619
 Ball : CF8M / 1.4408
 Stem : 316 S.S. / 17-4 PH
 Seats : PTFE, RTFE, TFM1600
 Face to Face : ANSI B16.10
 EN558-1, GR.1/GR.27
 (DIN3202-F1,F4/F5)

- NACE MR-0175 On Request



SERIES 96D ANSI CLASS 600

Direct Mount Design
 Fire Safe Tested to API 607 6th Edition
 Size: 1/2" - 4" Full Port
 Body : CF8M / WCB,
 Ball: 316 S.S. / CF8M
 Stem: 316 S.S. / 17-4 PH
 Seats: PTFE, RTFE, TFM1600
 Face to Face: ANSI B16.10

- NACE MR - 0175 On Request



SERIES 96DX Double Body Gasket Design ANSI CLASS 600

Direct Mount Design
 Fire Safe Tested to API 607 6th Edition
 Size : 1/2" - 4" Full Port
 Body : CF8M/WCB
 Ball : 316 S.S. /CF8M
 Stem : SS316/17-4 PH
 Seats : PTFE, RTFE, TFM1600
 Face to Face : ANSI B16.10

- NACE MR-0175 On Request



MARS HIGH PERFORMANCE FLANGED BALL VALVES



SERIES 91D ANSI CLASS 150, 300

Direct Mount Design
Fire Safe Tested to API 607 4th & 6th Edition
Size: 1/2" - 6" Reduced Port
Body: CF8M / WCB
Ball: 316 S.S. / CF8M
Stem: 316 S.S. / 17-4 PH
Seats: PTFE, RTFE, TFM1600
Face to Face: ANSI B16.10
● NACE MR - 0175 On Request



SERIES 99 WAFER TYPE COMPACT BALL VALVE PN 16/40, ANSI CLASS 150

Direct Mount Design
Fire Safe Design in Compliance with API 607
Size: 1/2" - 6" Full Port
Body: CF8M / WCB, 1.4408 / 1.0619
Ball : CF8M / 1.4408
Stem : 316 S.S./17-4 PH
Seats: PTFE, RTFE, TFM1600
● NACE MR - 0175 On Request



ECONOMICAL FLANGED BALL VALVES

Your extremely economical valve solutions



SERIES 90S ANSI CLASS 150, PN16/40, FULL PORT

Size: 1/2" - 4"
Body: CF8M / WCB, DIN 1.4408 / 1.0619
Ball/Stem: 316 S.S.
Seats: PTFE, RTFE, TFM1600
Face to Face: ANSI B16.10, DIN EN 558-1, GR. 1/GR.27 (DIN 3202-F1, F4/F5)

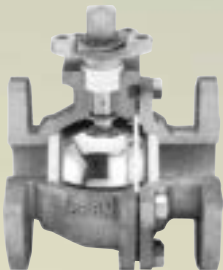

SERIES 93 ANSI CLASS 150, 300, PN16/40, JIS 10K, 20K, FULL PORT

Size: 5" - 12"
Body: CF8M / WCB, DIN 1.4408 / 1.0619, SCS14A / SCPH2
Ball/Stem: 316 S.S. / 17-4 PH
Seats: PTFE, RTFE, TFM1600
Face to Face: ANSI B16.10, DIN EN 558-1, GR. 1/GR.27 (DIN 3202-F1, F4/F5)



SERIES 94 ANSI CLASS 150, 300, PN 16/40, FULL PORT

Size: ANSI Class 150 & DIN PN 10/16 1/2" to 12"
ANSI Class 300 1/2" to 10" & DIN PN 25/40 1/2" to 4"
Body: CF8M / WCB, DIN 1.4408 / 1.0619
Ball/Stem: 316 S.S.
Seats: PTFE, RTFE, TFM1600
Face to Face: ANSI B16.10, DIN EN 558-1-27 (DIN 3202 F4/F5)



SERIES 94D ANSI CLASS 150, PN 16, FULL PORT

Direct Mount Design
Size: 1/2" to 4"
Body: CF8M / WCB, DIN 1.4408 / 1.0619
Ball/Stem: 316 S.S.
Seats: PTFE, RTFE, TFM1600
Face to Face: ANSI B16.10, DIN EN 558-1-27 (DIN 3202 F4/F5)



MULTI-PORT 3-WAY, 4-WAY, 5-WAY BALL VALVES

Stainless Steel and Carbon Steel



Series 30 3-Way/4-Way, ANSI Class 150, 300, PN16 - 40

- Trunnion Ball Design
- Full Port
- ISO 5211 Mounting Pad.
- 3-Seats Design
- Gland Stem Packing

Size: 1 1/2" - 12"

Ball Configuration: L-Port, T-Port, X-Port

Material: CF8M/WCB, 1.4408 / 1.0619

Seats: PTFE, RTFE, TFM1600

Ends: Flanged



Series 33 3-Way, 4-Way, 5-Way



- Direct Mount Design
- Full Port
- Semi-Trunnion Ball Design
- 5-Seats Design
- Live loading stem

Size: 1/4" - 4"

Ball Configuration: L-Port, T-Port, I-Port, X-Port,
LL-Port, TT-Port

Ratings: 1000 PSI max

Flanges to ANSI Class 150, 300, PN 16 - 40

Ends: Threaded, Socket Weld, Butt Weld, Flanged



Series 36 3-Way, 4-Way

- Direct Mount Design
- Full Port & Reduced Port
- 1/4" - 2" Floating Ball
- 2 1/2" - 12" Trunnion Ball
- 4-Seats Design
- Live loading stem

Size: 1/4" - 12"

Ball Configuration: L-Port, T-Port, X-Port, I-Port

Ratings: 1000 PSI max

Flanges to ANSI Class 150, 300, PN 10 - 40

Ends: Threaded, Socket Weld, Butt Weld, Flanged

SERIES 33 AND SERIES 36 VALVE CONSTRUCTION COMPARISON TABLE

| FIG. No. & End Connections | FIG. 33-10 Threaded FIG. 33-20 Socket Weld FIG. 33-30 Butt Weld | FIG. 36-10 Threaded FIG. 36-20 Socket Weld FIG. 36-30 Butt Weld | FIG. 33-40 ANSI 150# FIG. 33-50 ANSI 300# FIG. 33-60 PN 10/16 FIG. 33-70 PN 25/40 | FIG. 36-40 ANSI 150# FIG. 36-50 ANSI 300# FIG. 36-60 PN 10/16 FIG. 36-70 PN 25/40 |
|--|--|---|--|--|
| Size Range | 1/4" - 4" | 1/4" - 4" | 1/2" - 4" | 1/2" - 12"CL150&PN 10/16 1/2" - 8"CL300&PN 25/40 |
| Full Port | 1/4" - 4" | 1/4" - 4" | 1/2" - 4" | 1/2" - 10" |
| Reduced Port | N/A | 1/4" - 2" | N/A | 12" |
| Seats Design | 5-Seats | 4-Seats | 5-Seats | 4-Seats |
| Cavity Filler Seats | Patented Cavity Filler Seats Covering more than 95% of the dead space inside valve | Available on request | Patented Cavity Filler Seats Covering more than 95% of the dead space inside valve | Available on request |
| Semi-Trunnion Ball or Trunnion Ball | Semi-Trunnion Ball Design | 1/4" - 2" Floating Ball 2 1/2" - 4" Trunnion Ball | Semi-Trunnion Ball Design | 1/2" - 2" Floating Ball 2 1/2" - 12" Trunnion Ball |
| Pressure Rating | 1/4" - 1" 1000 PSI 1 1/4" - 2" 800 PSI 2 1/2" - 3" 600 PSI 4" 300 PSI | 1/4" - 1" 1000 PSI 1 1/4" - 4" 800 PSI | ANSI CLASS 150, 300 PN 10 - 40 | ANSI CLASS 150, 300 PN 10 - 40 |
| Flow Pattern | L-, T-, X-, I-, LL-, TT Vertical L- & T-Port | L-, T-, X-, I-Port | L-, T-, X-, I, LL, TT, Vertical L- & T-Port | L-, T-, X-, I-Port |
| Bottom Entry | Available | On request | Available | On request |
| End Cap & Seat Retainer | 2-Piece Design, Easy in-Line Maintenance | One-Piece Design | 2-Piece Design, Easy in-Line Maintenance | One-Piece Design |
| Body & End Caps Construction | 1/4" - 3" Investment Casting 4" Body -Sand Cast Ends -Investment Cast | 1/4" - 4" Investment Casting | 1/2" - 3" Investment Casting 4" Body - Sand Cast Ends -Investment Cast | 1/2" - 5" Investment Casting 6" - 12" Sand Cast |

3-WAY BALL VALVES, T-PORT or L-PORT

Stainless Steel and Carbon Steel



SERIES 38

- 1/4" - 3" Reduced Port
 - L-Port, T-Port
 - 4-Seats Design
 - Gland Stem Packing
 - ISO 5211 Mounting Pad
- Ratings: 1000 PSI max.
Ends: NPT, BSP, BSPT



SERIES 39

Direct Mount Design



- 1/4" - 2" Full Port & Reduced Port
 - L-Port, T-Port
 - 4-Seats Design
 - Live Loading Stem
 - ISO 5211 Mounting Pad
- Ratings: 1000 PSI max.
Ends: NPT, BSP, BSPT



SERIES 83D

- 1/4" - 2" Full Port & 1/2" - 2" Reduced Port
 - Side Opening or Bottom Opening
 - L-Port, T-Port
 - 2-Seats Design
 - Live Loading Stem
 - ISO 5211 Mounting Pad
- Ratings: 1500/2000 PSI max.
Ends: TH, SW, BW, FL



SERIES 88D Direct Mount Design

- 1/4" - 1 1/2" Full Port & 1/2" - 2" Reduced Port
 - Side Opening or Bottom Opening
 - L-Port, T-Port
 - 2-Seats Design
 - Live Loading Stem
 - ISO 5211 Mounting Pad
- Ratings: 1500/2000 PSI max.
Ends: TH, SW, BW, FL

TANK BOTTOM BALL VALVES

- 3-piece swing-out design, easy in-line maintenance
- Cavity filler seats on request
- End connections available in Threaded, Socket Weld, Butt Weld, and flanged ends ANSI 150#, PN 10/40



SERIES 50TB



SERIES 55TB



SERIES 77TB
Direct Mount Design

ULTRA-PURE HIGH PERFORMANCE SANITARY BALL VALVES



FIG. 77SN-10
Tri-Clamp Ends



FIG. 77SN-20
Tube OD Butt Weld Ends



SERIES 77SN
Direct Mounting Design
Size: 1/2" - 4"
True Tube Full Port
Body, Ends: CF3M
Ball: CF3M / 316L S/S
Stem: 316L S/S
Seats: PTFE
Rating: 1000 PSI max.

SERIES 88SN

Direct Mounting Design
Size: 1/2" - 4"
True Tube Full Port
Body, Ends: CF3M
Ball: CF3M / 316L S/S
Stem: 316L S/S
Seats: PTFE
Rating: 1000 PSI max.



FIG. 88SN-10
Tri-Clamp Ends



FIG. 88SN-20
Tube OD Butt Weld Ends

SERIES 83SN

Size: 1/2" - 2"
True Tube Full Port
Body, Ends: CF3M
Ball: CF3M / 316L S/S
Stem: 316L S/S
Seats: PTFE
Rating: 1000 PSI max.



FIG. 83SN-10
Tri-Clamp Ends



FIG. 83SN-20
Tube OD Butt Weld Ends

SERIES 33SN SANITARY BALL VALVE

3-WAY, 4-WAY, 5-WAY
Direct Mount Design
Size: 1/2" - 4" 1000 PSI max.

- True Tube Full Port
- Cavity Filler Seats Available
- Compact design, easy wash-downs and cleaning

Body, Ends: CF3M
Ball: CF3M / 316L S/S
Stem: 316L S/S
Ends: Tri-clamp Tube OD Butt Weld
Seats: PTFE



BUTTERFLY VALVES

Size: 1" - 4"
Body, Disc: 316L S/S, 316 S/S,
304 S/S
Seats: EPDM, VITON, SILICON
Ends: Clamp / Weld / Male



ULTRA-PURE ECONOMICAL SANITARY BALL VALVES

Size: 1/2" - 4"
True Tube O.D. Full Port
Body, Ends: CF8M, CF3M
Ball: CF8M / 316 S/S
Stem: 316 S/S
Seats: PTFE
Rating: 1000 PSI max.
Ends: Tri-Clamp
Tube OD Butt Weld



SERIES 55SN
Live Loading Stem
ISO 5211 Mounting Pad



SERIES 50SN
• Gland Stem Packing

MARS V-PORT CONTROL BALL VALVE IS DESIGNED FOR PRECISE MODULATING APPLICATIONS

SERIES 88V

Direct Mount Design



- With our standard ball valves, the V-Notched Ball is available with 30°V, 60°V, and 90°V Notch
- Low maintenance costs compared to Globe and Segmented Ball Valves
- Easy and Low Cost Automation with Mars Patented Direct Mount Ball Valves.
- Compact and Light weight - Smaller and lighter than Globe Control Valve



30°V, 60°V, and 90°V Notch standard, others on request



SERIES 83V



SERIES 90V



SERIES 90DV
Direct Mount Design



SERIES 99V
Direct Mount Design

STEAM JACKET BALL VALVES

Jacketed ball valve prevents solidification and blockages in use hot water, steam, or other appropriate heating or cooling medium.



SERIES 90J
Direct Mount Design
Size: 1/2" - 4"



SERIES 90DJ
ANSI CLASS 150, 300, PN 10-40
Direct Mount Design
Size: 1/2" - 8"



SERIES 91DJ
ANSI CLASS 150, 300
Direct Mount Design
Size: 1/2" - 6"



SERIES 99J
PN 10-40, ANSI 150
Direct Mount Design
Size: 1/2" - 4"



SERIES 83J
ISO 5211 Mounting Pad
Size: Full Port 1/4" - 2"
Reduced Port 1/2" - 2"
2000 PSI max.
Ends: TH, SW, BW, FL



SERIES 88J
Direct Mount Design
Size: Full Port 1/4" - 1 1/2"
Reduced Port 1/2" - 2"
2000 PSI max.
Ends: TH, SW, BW, FL

MARS-INOX THREE-PIECE BALL VALVES

Stainless Steel and Carbon Steel 1/4"-4", Full Port, 1000PSI

Design Benefits:

- Loose Ends design allows ball valve 360° rotation around the pipe, free position.
- No risk of misalignment of connections after welding
- Time saving and low cost welding - No need to take care the position of connections when welding ball valve with pipe line.



SERIES 55L

- Economical
- Manual and Automated
- ISO 5211 Mounting Pad
- Live Loading Stem



SERIES 50L

- Economical
- Manual
- Gland Stem Packing



★ Available End Connections: Threaded, Socket Weld, Butt Weld



SERIES 77L

- Direct Mount Design
- High Performance
- Manual and Automated
- Live Loading Stem

DOUBLE BLOCK AND BLEEDING BALL VALVES

For use in critical applications, Cost Reducing - Space Saving - Light Weight
Valve material: Stainless Steel, Carbon Steel.

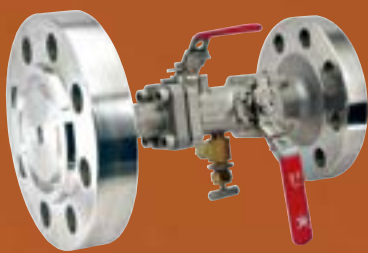

Face-to-Face to ANSI B16.10

TITANIUM BALL VALVES

Light weight - Excellent corrosion resistance

Titanium is resistant to corrosive attack by sea water or marine atmospheres, better than any other materials, It also exhibits exceptional resistance to a broad range of acids, natural waters and chemicals. Titanium ball valves present successful application for sea water and chemical plant duties.

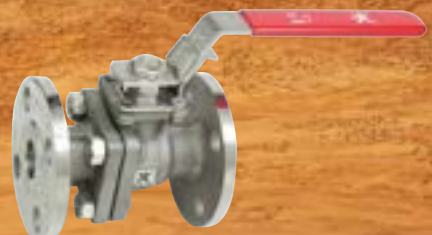

CRYOGENIC BALL VALVES

Sizes: 1/2" to 4"

End Connections: including ANSI 150# / 300#, DIN PN 10/40 and flanges, Threaded, Butt Weld, and Socket Weld

Temperature: down to -196°C / 452°F



SERIES M8C



SERIES M8C



SERIES M9C

Design Features

- ISO 5211 mounting pad with square shaft allows an actuator bolted directly to the top of ball valve, no bracket and adapter are required, provides easy and low cost automation with improved cycling life.
- Each valve marked a flow direction arrow to prevent incorrect installation.
- A vented ball eliminates pressure build up in ball cavity.
- Oxygen cleaning standard.
- A solid high strength 17-4 ph stainless steel stem provides maximum strength and stability to ensure ball rotation in high torque cryogenic service.



SERIES 83C

1/2" - 2" Full & Reduced Port
1000 PSI max.



Easy Automation with Mars
Patented Direct Mount Design



SERIES 90C

1/2" - 4" Full Port
ANSI CL 150, 300, PN 10-40



Easy Automation with Mars
Patented Direct Mount Design

Mars-Lok Instrumentation Ball valves and Check Valve

Mars-Lok Instrumentation Ball Valves designed for general service and instrumentation panels, Providing standard valve values but other valve manufacturers charge extra for.



Easy & Low cost Automation with Mars Patented Direct Mount Design



1/4" - 3/4", 2000 PSI max.

SERIES 300

- Direct Mounting of Actuator, No Brackets and Couplings needed for automation.
- Bi-directional flow
- Mars Triple-Sealing, Live Loaded Stem Packing, TA-Luft approved, provides optimum stem seal and extremely high-cycle life.
- 3-Piece swing-out design, easy in-line maintenance
- Blow-Out Proof Stem
- Silver Plated Nut standard
- Heat Treated Ferrules standard
- Variety of End Connections for options



FIG. 100
1/4" - 3/4", 1000 PSI
Mars-Lok Tube Fitting



FIG. 200A
1/4" - 3/4", 3000 PSI
Mars-Lok Tube Fitting



FIG. 200B
1/4" - 1/2", 3000 PSI
Mars-Lok / NPT or BSP



FIG. 200C
1/4" - 1/2", 3000 PSI
Male/Female NPT or BSP



FIG. 200D
1/4" - 1/2", 3000 PSI
Male/Female NPT or BSP



FIG. 200E
1/4" - 1/2", 3000 PSI
Female/Female NPT or BSP

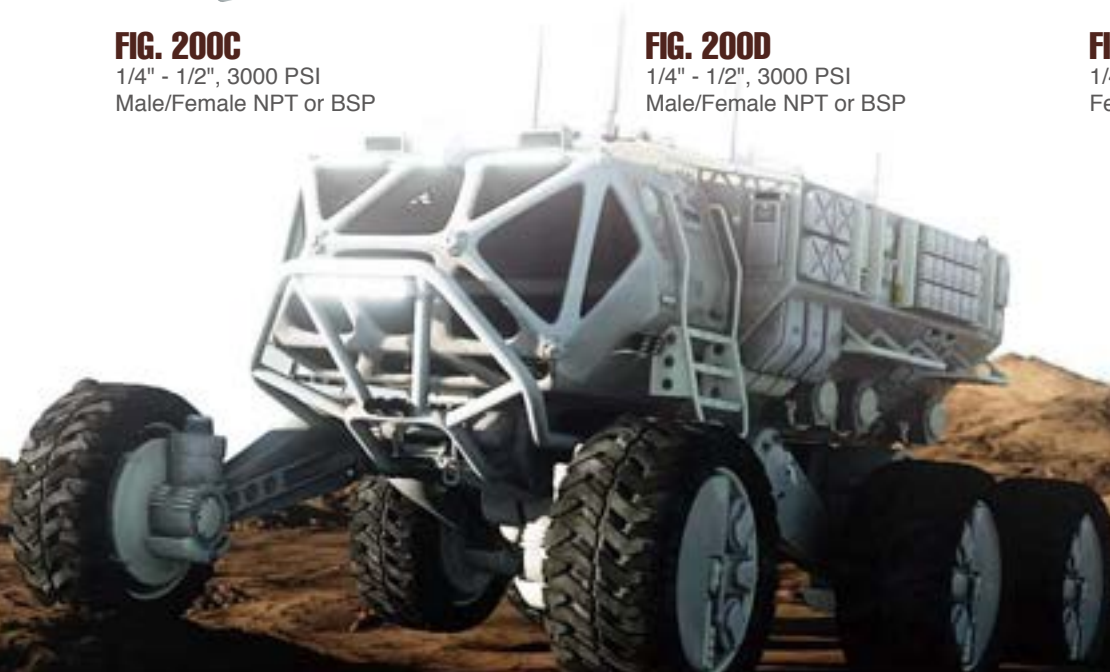

Mars-Lok Instrumentation Ball valves and Check Valve

MARS-LOK TUBE FITTINGS



In-Line Check Valve Compact Size, Metal to Metal Seal, Rugged Construction

Size: 1/4" - 1"

Working Pressure: 2000 PSI.

Cracking Pressure: 1/3 PSI, 3 PSI, 10 PSI

Working Temperature: 180°C max. - With Viton Seal

Body: 316 S.S.

Spring: 304 S.S.

Poppet: 316 S.S.

'O'Ring: Viton

Gasket: Viton, PTFE

End Connections: Screwed Female / Male,
Instrumentation Tube, Combinations

- Valves with higher working pressure on request
- Reseal pressure depends on cracking pressure



HIGH PRESSURE / PANEL MOUNTING BALL VALVES - STAINLESS STEEL 6,000 PSI



SERIES LOK35Mk

Stainless Steel

Size: 1/4" ~3/4"

Rating: 6000 PSI

Body : CF8M

Cap : SS316

Seat : PEEK

With Handle

Above not including Ferrule, Ferrule Nut

Design Advantages:

- The valve is easy to mount to a control panel
- Bi-directional floating ball design allows bubble tight shut off on pressure
- Variety of end connections for options
- Panel mounting style, can be supplied suitable for actuation.

GATE VALVE, GLOBE VALVE, CHECK VALVE, NEEDLE VALVE

NEEDLE VALVE



ND-6000
Size: 1/8" - 2" 6000 PSI
Body: CF8M



ND-6000A
Size: 1/4" - 1" 6000 PSI
Body: CF8M



AND-6000
Size: 1/4" - 1" 6000 PSI
Body: CF8M



AND-6000A
Size: 1/8" - 1" 6000 PSI
Body: CF8M



ND-10000
Size: 1/8" - 1" 10000 PSI
Body: SS316



AND-10000
Size: 1/8" - 1" 10000 PSI
Body: SS316

GATE VALVE



GT-200
Size: 1/2" - 2"
200 PSI
Body: CF8M

GLOBE VALVE



GB-200
Size: 1/4" - 2"
200 PSI
Body: CF8M



YGB-800
Size: 1/4" - 2"
800 PSI
Body: CF8M

Y-STRAINERS



YS-800
Size: 1/4" - 3"
800 PSI
Body: CF8M



YS-F
Size: 1/2" - 12"
CF8M / WCB / 1.4408
/ 1.0619 / SCS14A /
SCPH2
ANSI CL 150, 300
PN 10-40
JIS10K/20K

CHECK VALVE



**SW-200
Swing Check Valve**
 • Size: 3/8" - 3" • 200 PSI
 • Body: CF8M



**YSC-800
Y-Pattern Spring Check Valve**
 • Size: 1/4" - 3" • 800 PSI
 • Body: CF8M



**WC-100
Wafer Check Valve**
 • Size: 1/2" - 8"
 • ANSI CL 150, 300
 • DIN PN 10 - 40
 • Body: CF8M



**SLC-3
3-Piece Spring Loaded
Check Valve**
 Size: 1/4" - 4" 1000 PSI max.
 Body: CF8M
 Ends: Threaded, Socket Weld,
 Butt Weld

Dual Plate Wafer Type Check Valve

Size: 2" - 24"

Installation Dimensions: • ANSI 125-2500
 • PN 10-40
 • JIS 10K, 20K

VALVE MATERIALS

Body ASTM A126 Class B, A536 65-45-12

A216 WCB, CF8, CF8M, CF3M

Plate B584 C836, B148 C958,

A216 WCB, CF8, CF8M, CF3M

Seats NBR(BUNA-N), NEOPRENE, VITON

316 S/S overlay, 410 S/S overlay
 Stellite overlay



FIG. DWC-1



FIG. DWC-2

SERIES 61 STAINLESS STEEL KNIFE GATE VALVE 2" – 24" ANSI 150#, DIN PN 10/16, JIS 5K/10K

- High-quality, full port design
- Compact, Low Profile
- Metal or Resilient Seat
- Precision-buffed stainless steel gate
- Manual, Gear Operator, Pneumatic or Electric Cylinder

Body: CF8M, CF8, CF3M

Knife: S.S. 316, S.S. 304, S.S. 304L, S.S. 316L

Seat: Metal, Teflon, VITON, EPDM

Packing: NON-ASB+PTFE, ASB, ASB+PTFE, TEFLON, NON ASBESTOS

| Resilient Seat Material | Temperature |
|-------------------------|---------------|
| ASBESTOS + PTFE | -50°C ~ 550°C |
| VITON | -20°C ~ 250°C |
| TEFLON | -30°C ~ 150°C |
| NON ASBESTOS | -50°C ~ 550°C |

★ Each valve is pressure tested for seat tightness, shell and packing integrity to check for reliability operation



FIG. 61M
Manual



FIG. 61P
Pneumatic



FIG. 61E
Electric Cylinder



FIG. 66B
2-Stage
Pneumatic



FIG. 66C
Manual-Pneumatic
Switchover

SERIES 62 CAST IRON KNIFE GATE VALVE 2" – 24" ANSI 150#, DIN PN 10/16, JIS 5K/10K

Body: FC, FCD, WCB

Knife: S.S. 316, S.S. 304, S.S. 304L, S.S. 316L

Seat: Metal, Teflon, VITON, EPDM

Packing: NON-ASB+PTFE, ASB, ASB+PTFE, TEFLON, NON ASBESTOS



FIG. 62M
Manual



FIG. 62P
Pneumatic

SERIES 63 BOLTED BONNET KNIFE GATE VALVE 2" – 20" ANSI 150#, DIN PN 10/16, JIS 5K/10K

Body: FC, WCB, SCS13,
SCS14, SCS16
Knife: S.S. 316, S.S. 304,
S.S. 304L, S.S. 316L
Seat: Metal, Teflon,
VITON, EPDM
Packing: NON-ASB+PTFE,
ASB, ASB+PTFE,
Teflon, NON-ASBESTOS



FIG. 63M
Manual



FIG. 63P
Pneumatic

SERIES 64 PNEUMATIC BOLTED BONNET KNIFE GATE VALVE 2" – 24"

Body: CF8M, CF8, CF3M
Knife: S.S. 316, S.S. 304, S.S. 304L,
S.S. 316L
Seat: Metal, Teflon, VITON, EPDM
Packing: NON-ASB+PTFE, ASB,
Teflon, NON-ASBESTOS



SERIES 65 MANUAL KNIFE GATE VALVE ANSI 150#, DIN PN 10/16, JIS 5K/10K 4" – 24"

Body: CF8M, CF8, CF3M, FC, FCD
Knife: S.S. 316, S.S. 304, S.S. 304L,
S.S. 316L
Seat: Metal, Teflon, VITON, EPDM
Packing: NON-ASB+PTFE, ASB,
ASB+PTFE, Teflon, NON-ASBESTOS



MADE IN TAIWAN

SERIES 32 PNEUMATIC THREE WAY DIVERTER VALVE

ANSI 150#, DIN PN 10/16, JIS 5K/10K

- Ball Type
- Stainless steel body construction
- Size range
2" to 10" Ball Type



FIG. 32B BALL TYPE

STAINLESS STEEL GATE VALVE Outside screw & Yoke bolted bonnet flanged ends

ANSI 150#, ANSI 300#, DIN PN 10/16, JIS 10K, JIS 20K

Size range

ANSI 150# / JIS 10K 1/2" to 24"

ANSI 300# / JIS 20K 1/2" to 16"

PN 10/16 1/2" to 12"

Design Standard

API 603

Shell wall thickness ANSI B16.34

Face to face ANSI B16.10, DIN 3202, JIS B2002

Flanges to ANSI B16.5, DIN 2501 JIS B2210



ANSI 150# / JIS 10K



ANSI 300# / JIS 20K



DIN PN 10/16

STAINLESS STEEL GLOBE VALVE Outside screw & Yoke bolted bonnet flanged ends

ANSI 150#, ANSI 300#, DIN PN 10/16, JIS 10K, JIS 20K

Size range

ANSI 150# / JIS 10K 1/2" to 16"

ANSI 300# / JIS 20K 1/2" to 10"

PN 10/16 1/2" to 12"

Design Standard

Shell wall thickness ANSI B16.34

Face to face ANSI B16.10, DIN 3202, JIS B2002

Flanges to ANSI B16.5, DIN 2501, JIS B2210



ANSI 150# / JIS 10K



ANSI 300# JIS 20K



DIN PN 10/16

STAINLESS STEEL Y-TYPE GLOBE VALVE

Outside screw & Yoke bolted bonnet flanged ends

1/2" to 12", ANSI 150#, DIN PN 10/16, JIS 10K

Design Standard
 Shell thickness ANSI B16.34
 Face to face ANSI B16.10, JIS B2002
 Flanges ANSI B16.5, DIN 2501, JIS B2210



STAINLESS STEEL CHECK VALVE

ANSI 150#, ANSI 300#, DIN PN 10/16, JIS 10K, JIS 20k

Size range
 ANSI 150# / JIS 10K 1/2" to 24"
 ANSI 300# / JIS 20K 1/2" to 12"
 PN 10/16 1/2" to 12"

Design Standard
 Shell wall thickness ANSI B16.34
 Face to face ANSI B16.10, DIN 3202, JIS B2002
 Flanges to ANSI B16.5, DIN 2501, JIS B2210



ANSI 150# / JIS 10K



ANSI 300# JIS 20K



DIN PN 10/16

STAINLESS STEEL LIFTTYPE CHECK VALVE

1/2" TO 16", ANSI 150#, JIS 10K

Design Standard
 Shell thickness ANSI B16.34
 Face to face ANSI B16.10, JIS B2002
 Flanges ANSI B16.5, DIN 2501, JIS B2210



MARS ANGLE SEAT VALVE

- Double Acting or Spring Return
- Upright, flat, or angled, all position assembling available
- Extended cycle life guaranteed



Size range: 1/2" to 2"
 Valve material: ASTM A351 Gr. CF8M - DIN 1.4408
 Stem and Plug: AISI 316
 Actuator cylinder: Industry Plastic(PA66-GF30%)
 Pressure: 0 to 16/25 bar
 Steam 180°C, from 0 to 10 bar
 Temperature: -10°C to 180°C
 Viscosity: 600 cst(mm2/s)
 End connections: NPT, BSP, BSPT, Socket weld,
 Flange End (DIN, ANSI, JIS) & Clamp End.
 Applications: Air, Water, Steam, Alcohol,
 Petrol, Oil, Saline solutions, etc.
 Control media: Compressed air, dry or lubricated, gas,
 or Neutral media

P.S. Flange End and Clamp End are Welded, not integrative Shaping.

| N0 | PARTS | MATERIALS |
|----|-------------------|------------------|
| 1 | Valve body | A351-CF8M |
| 2 | Sleeve | A351-CF8M |
| 3 | Stem | AISI 316 |
| 4 | Plug | AISI 316 |
| 5 | Plug seals | PTFE |
| 6 | Actuator cylinder | INDUSTRY PLASTIC |
| 7 | Threading inserts | AISI 304 |
| 8 | Piston | Brass |

SERIES 600 Direct Mount Top Entry Ball Valve

Body: Stainless Steel or Carbon Steel as standard.
 Hasstalloy C, Monel, Super Duplex,
 and Alloy 20 are available for options

Size: 1/2" to 4"

End Connections: Flanged to ANSI 150# / 300#, DIN PN 10/16, PN 25/40

Pressure Rating: Threaded, Socket Weld, Butt Weld - 800 PSI

Face to Face: ANSI B16.10, DIN 3202 F1

Flange Dimensions: ANSI B16,5, DIN 2543 and DIN 2545

Design Features

- Direct mount design, no bracket and adapter are required for actuator mounting, provides easy and low cost automation with improved cycle life.
- Designed for easy in-line maintenance
- Investment Cast Body with Compact Design
- Live loading stem design automatically adjusts seal to compensate for wear, temperature and Pressure fluctuations.
- Blow-out proof stem
- Fire-Safe design as option



MARS PFA LINED BALL VALVE

To compensate for gland packing, Gland bolts can be slightly tightened to recompress gland packing

Pressure : PN16/PN40

2-Piece Flange Ball Valve
Size : DN15 ~ DN100 (1/2" ~ 4")
Operation Temperature : -20°C~180 °C
Body : EN10213 - 1.4408 Investment Cast
EN1563 - 5.3103 Sand Cast

Mounting Top
Cavity minimizes design
Anti-static design
Minimum 3mm PFA lining

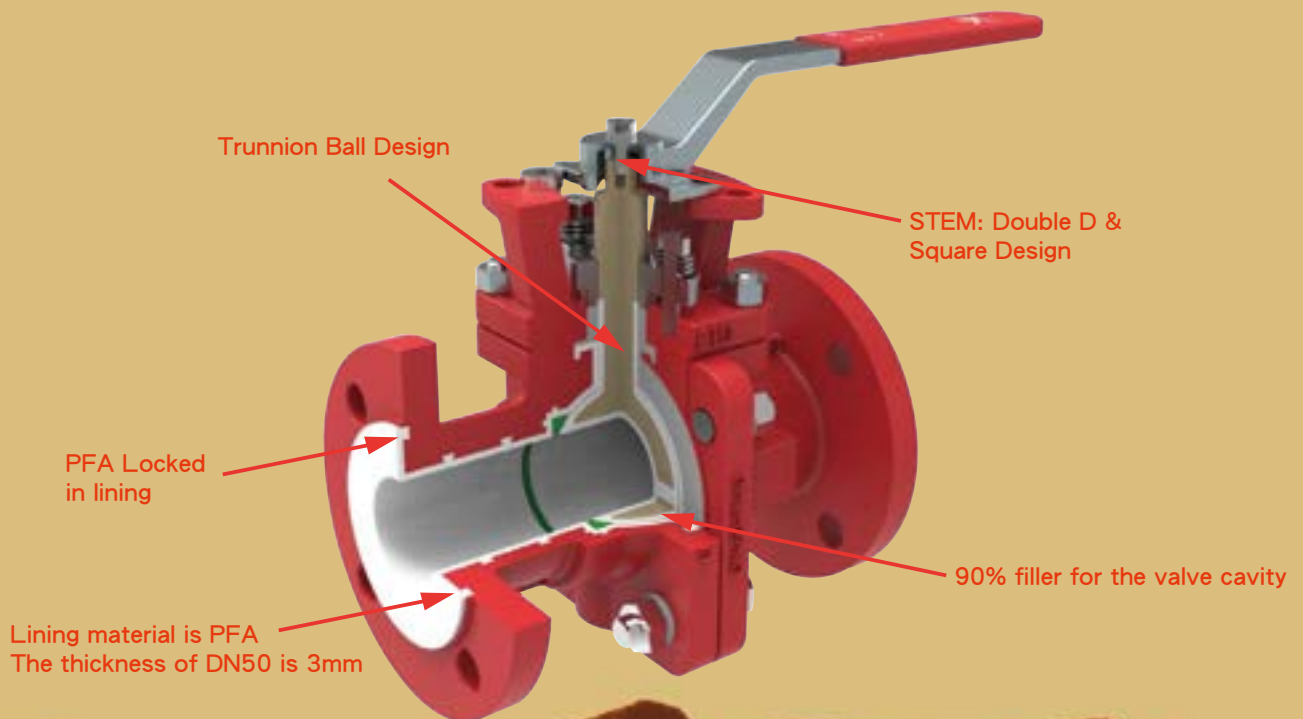
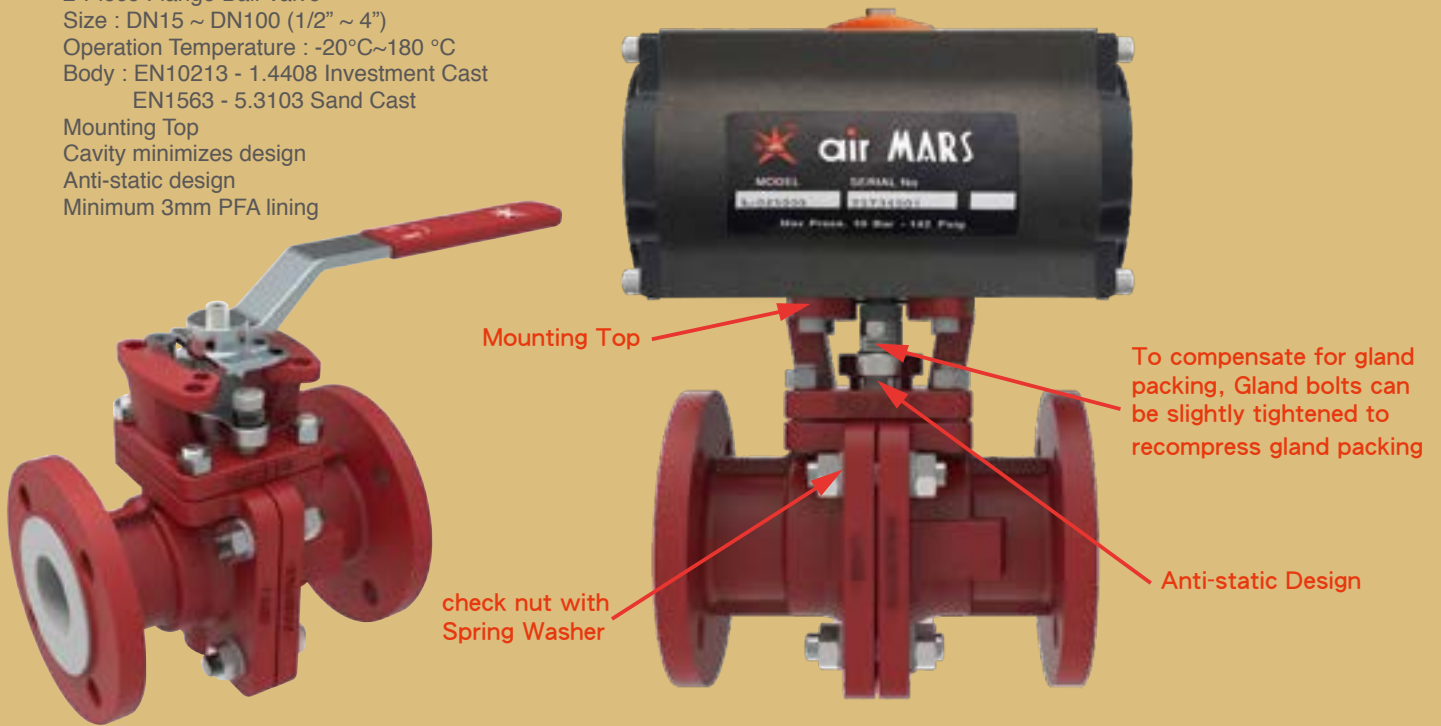

SERIES 90DA MARS Direct Mount High Performance Flanged Ball Valves

Submerged packing adjustment allows in-line packing adjustment with operators and actuators mounted.

ANSI CLASS 150 / 300, PN 16 - 40

Stainless Steel & Carbon Steel

- Size: 1 1/2" - 8"
- Full Port
- Compliant to ASME B16.34, API 6D an API608
- Fire safe design to API 607
- NACE MR-0175 on request

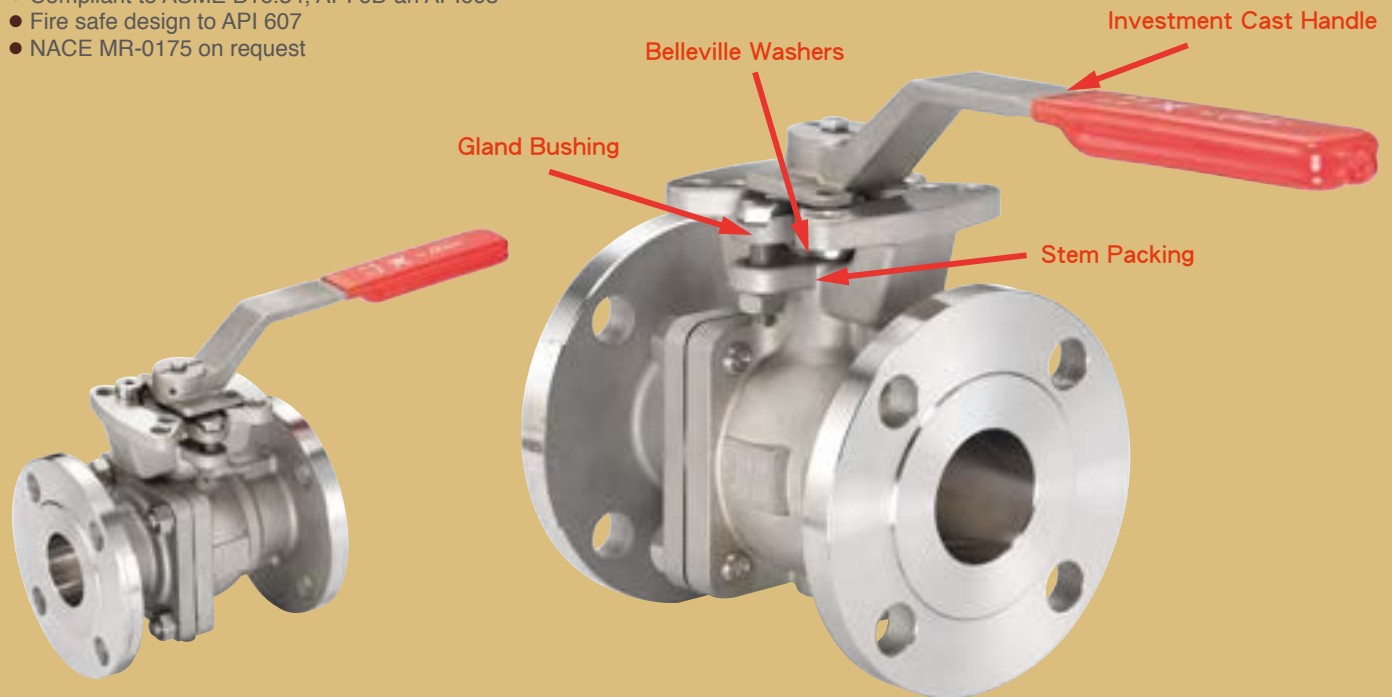

SERIES 88X High Performance Three Piece Ball Valves



Stainless Steel & Carbon Steel

- The Series 88X is in Full Compliance with ASME B16.34
- Double Body Gasket Design ensures positive body joint sealing, provides extra long life cycle
- Fire-Tested to API 607 6th Edition
- Direct Mount Design, Easy Automation
- Size: 1/4" - 4"
- Full Port & Reduced Port
- End Connections: Threaded, Socket Weld, Butt Weld
- Pressure Rating: 1/4" - 1" 2000 PSI (Class 800)
1 1/4" - 2" 1500 PSI (Class 600)
2 1/2" - 4" 1000 PSI (Class 400)



METAL SEATED BALL VALVES

- Three-Piece Ball Valves, Class 600 & Class 900, Threaded, Socket Weld, Butt Weld Ends
- Split-Body Flanged Ball Valves ANSI 150#, 300#, 600#, DIN PN 10/16, PN 25/40
- One-Piece Flanged Ball Valve ANSI 150#
- Three-Piece Flanged Ball Valve ANSI 150#
- Three-Piece Trunnion Flanged Ball Valve, ANSI 150#, 300#, 600#
- Two-Piece Ball Valve, Class 150



Design Features

1. Stainless Steel or Carbon Steel Body
2. Stainless steel ball with hard chrome plated
3. S.S. 316 seats hard-faced with Stellite
4. Temperature to 500°C max.
5. The ball and seats are precision machined and lapped together to provide an extremely tight fit
6. Seat leakage rates equivalent to FCI 70-2, Class V

FLANGES

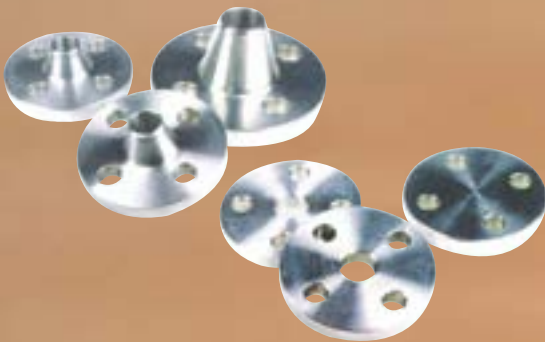

Forged or Cast Steel & Stainless Steel

Standards: ANSI, DIN, JIS...etc.
 Size: 1/2" - 72"
 Pressure Rating: CL 150 - CL 2500

PIPE FITTINGS



Investment Cast, Stainless Steel 1/4" - 4". CL150



Forged Stainless Steel & Carbon Steel
 1/8" - 4", Class 2000#, 3000#, 6000#

QUICK COUPLINGS (Stainless Steel, Aluminum, Bronze, Brass)



TYPE A



TYPE B



TYPE C



TYPE D



TYPE DC



TYPE DP



TYPE E



TYPE F

Mars Valve is also specializing in investment casting and precision machining of castings. With tooling, casting, machining, finishing and assembly capabilities - we are an unparalleled resource for single source operation. Contact us for your next castings and machining parts requirements, we are just seconds away via e-mail: mars@marsvalve.com.tw



MARS Investment Cast Advantages

- Freedom of design
- High production rates
- High dimensional accuracy
- High dimensional consistency
- High Integrity castings
- Long/Short runs can be accommodated
- Machining can be reduced or eliminated
- Minimum finish of casting required
- Complex shapes can be cast

MARS SANITARY BUTTERFLY VALVES AND FITTINGS

For Food, Dairy, Beverage, Cosmetics, Chemical, and Pharmaceutical Industries



SIGHT GLASS



SG-10

Sight Glass Screwed Ends
Material : Cast Iron / CF8 /CF8M
Size : 1/2" ~ 2"

| Parts name | Material |
|------------|------------------------------|
| BODY | Cast Iron/ SUS 304 / SUS 316 |
| MAIN PART | SUS 304 |
| W.P. | 1-10 Kg/cm ² |
| W.T. | 100°C |



SG-40

Sight Glass Flanged Ends
Flanged Ends : JIS-10K/ANSI-150LB, DIN3202 PN16-F1
Material : Cast Iron / CF8 /CF8M
Size : 1/2" ~ 8"

| Parts name | Material | | |
|------------|-------------------------|---------|---------|
| BODY | Cast Iron | SUS 304 | SUS 316 |
| CAP | Cast Iron | SUS 304 | SUS 316 |
| GLASS | Tempered Glass | | |
| BOLT | SS 41 | SUS 304 | SUS 304 |
| PACKING | TV 1500 | PTFE | PTFE |
| W.P. | 1-10 Kg/cm ² | | |
| W.T. | 100°C | | |

Brackets and Adapters

Materials: 304 S/S or 316 S/S

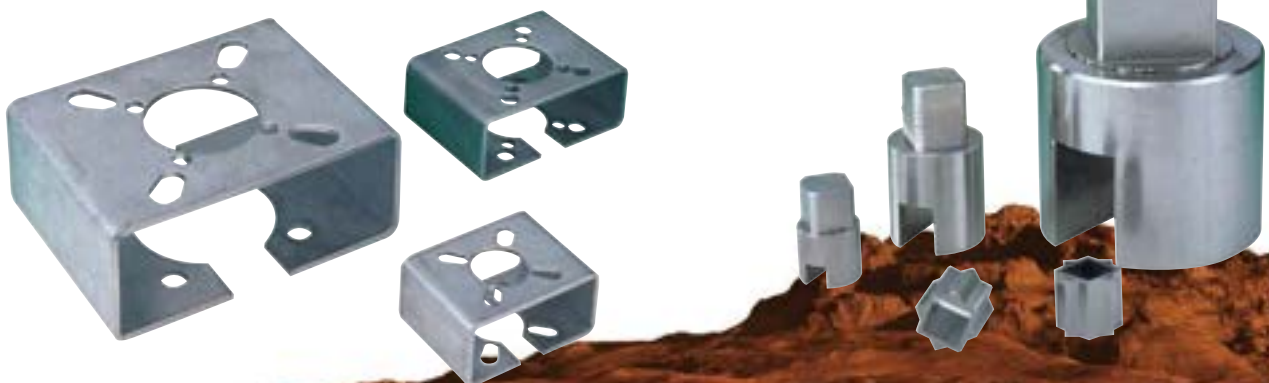

MARS SPRING LOADED SAFETY VALVES

Designed for liquids, gases, and steam

LOW LIFT TYPE : Model 601 and Model 201

Model 601

- All stainless steel construction
- Sizes: 3/4" to 2"
- Working Temperature/Working Pressure
- -196 °C to 290°C / 0.3 ~ 20 BAR (WITHOUT PTFE)
- -60 °C to 196 °C / 2 ~ 20 BAR (WITH PTFE)
- Seat/seal material:
 - Soft Seats : PTFE
 - Metal Seats : 316 SS, Stellite
- Flanges to ANSI 150#, 300#, PN 10-40, JIS 10K, 20K



Model 601-A
Male X Female Threaded



Model 601-B
Flanged X Female Threaded



Model 601-C
Flanged X Flanged



Model 601L-A
With Plain Lever
Male x Female Threaded



Model 601L-B
With Plain Lever
Flanged x Female Threaded



Model 601L-C
With Plain Lever
Flanged X Flanged

Model 201

- Valve body: Bronze
- Sizes: 1/2" to 2"
- Set pressure: 0.3 ~ 20 BAR
- Working temperature: -45°C to 185°C
- Soft seats or Metal to Metal design



Model 201-A
Male X Female Threaded



Model 201L-A
With Plain Lever
Male X Female Threaded

FULL BORE TYPE: Model 606 and Model 301

Model 606

- All stainless steel construction
- Sizes: 3/4" to 2"
- Set pressure: 2 BAR ~ 16 BAR
- Working temperature:
 - 196 °C to 290°C (WITHOUT PTFE)
 - 60 °C to 196 °C (WITH PTFE)
- Seat/seal material:
 - Soft Seats : PTFE
 - Metal Seats : 316 SS, Stellite
- Flanges to ANSI 150#, 300#, PN10-40, JIS 10K, 20K

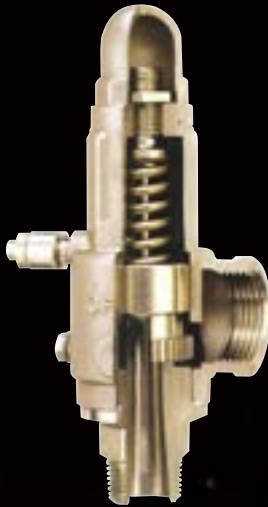

Model 606A
Male x Female Threaded



Model 606B
Flanged X Flanged

Model 606-C

Flanged x Female Threaded

Model 606L-A

With Plain Lever
Male X Female Threaded

Model 606L-B

With Plain Lever
Flanged x Female Threaded

Model 606L-C

With Plain Lever
Flanged X Flanged



MARS

Model 301

- Quality cast iron body and bonnet
- Disc: Stainless Steel
- Sizes: 3/4" to 2"
- Set Pressure : 1 BAR ~16 BAR
- Flanges to ANSI 150#, 300#, PN 10-40, JIS 10K, 20K
- Temperature
 - 5 °C to 220°C (WITHOUT PTFE)
 - 5 °C to 196 °C (WITH PTFE)
- Seat / seal material:
 - Soft seats: PTFE
 - Metal seats: 316 SS. Stellite

Model 301-A

Male X Female Threaded



Model 301-B

Flanged X Female Threaded



Model 301L-A

With Plain Lever
Male X Female Threaded



Model 301L-B

With Plain Lever
Flanged X Female Threaded



Mars Valve offers single-reliable-source for a complete line of valves, actuators, and accessories to meet your automation requirements.

Power Mars Electrical Actuators

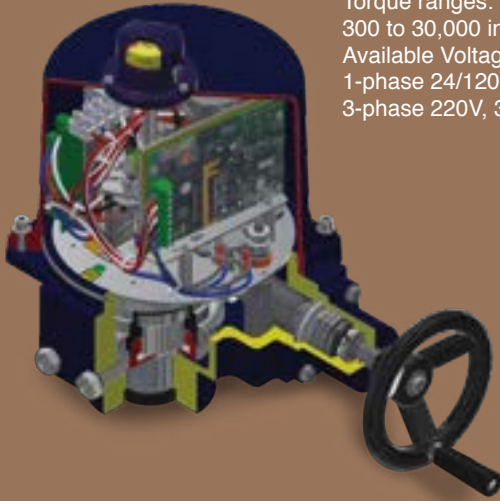

Torque ranges:
300 to 30,000 in-lbs
Available Voltages:
1-phase 24/120V/220V -12 & 24VDC
3-phase 220V, 380V, and 440V

Features

- NEMA 4,4x / IP 67 Construction
 - Die casting aluminum housing and cover
- CSA and CE approved
 - Self-locking gear train, no brake required
- Standard manual override with handwheel
 - Non-clutch design, manual override can be operated without lever, clutch, or brake upon power outage.
 - When actuator is operating, handwheel can't rotate for safety.
- Visual position indicator
- ISO 5211 mounting patterns



AirMars Pneumatic Actuator



A

- Double-acting or Spring return
- 125 to 11,000 in-lbs
- ISO / NAMUR Connections
- Aluminum alloy body
- Epoxy coated end caps
- Easy external bi-directional travel stop adjustment
- Extended cycle life guaranteed



B

- Double Acting & Single Acting
- Torque for Double Acting: 4.8Nm ~ 13024Nm
- Torque for Single Acting: 5.7Nm ~ 9523Nm
- ISO/NAMUR connection
- Aluminum Alloy Body
- Epoxy Coated End caps
- Adjustment Range: $\pm 5^\circ$ for the rotation at 0° and 90°
- Both for indoor and outdoor
- Extended Cycle Life Guaranteed

Limit Switch Box



Voltage:
Max 250V AC or DC



Current:
0.6A 125V DC or 16A 1/2HP

- IP 68 Waterproof and Explosion proof Exd II C T6
- Mechanical Switch
- Die casting Housing
- Visual position indicator
- "Quick-Set" Cam
 - Limit switch adjustment cams are splined and spring loaded, the switch cam position can be quickly adjusted without tools (close-up, open down)
- Easy mounting bracket
 - Any actuator for rotary can be easily mounted in ISO 5211

Mars Solenoid Valves



- NAMUR Interface
 - High Switch Reliability
 - No matter the orientation, valve can be mounted in any position
 - Valve body:
Aluminum anodized
 - Operating temperature:
0 - 50°C
 - Operating pressure:
22 - 118 PSI
 - Pressure resistance:
150 PSI
 - Coil voltage:
DC-12, 24
AC-110/50, 220/60
±10% of Normal
- ALL COILS ARE CE APPROVED

Pneumatic or Electro-Pneumatic Positioner



Mars Optional Valve Accessories Increase Productivity And Give You More Control Over Your Industrial Process

MARS "TSM" UNIT

A Fugitive emission Bonnet Compliance with EPA and TA-LUFT regulations.

Size Range: 1/4" to 6"

Material : 316 SS



DESIGN ADVANTAGES

- "TSM" unit is investment cast and equipped with Mars unique live loading stem packing
- Excellent, cost effective way to provide double sealing
- Offers dramatically improved cycle life, the best choice for high cycle applications.
- Purge ports available for the purpose of detecting primary seal leakage, it can be immediately observed and corrective action taken.
- Easy to insulate
- Easily mounted to Mars Series 22,33,77,83,88,90,90D,91D and 99 high performance ball valves

Mars "TSM" unit is designed for tomorrow, it can be added as an upgrade at later date to existing installations

ISO 5211 mounting pad and stem orientation allows direct mounting of actuator to valves, provides easy and low cost of automation.



SPRING RETURN SAFETY (SRS) HANDLE

The SRS handle is a spring energized handle, the ball valve will return to pre-determined closed (or open) position when a operator disengages from handle, provides safe and positive fail closed or open operation, creating a reliable sampling, filling, dispensing, and relief valves. Full stainless steel construction provides excellent corrosion resistance for extended service life.



The SRS handle is for use on Mars Series 22, 33, 77, 88, ball valves and "TSM" Unit



SPRING RETURN SLIDING LOCK (SRSL) HANDLE

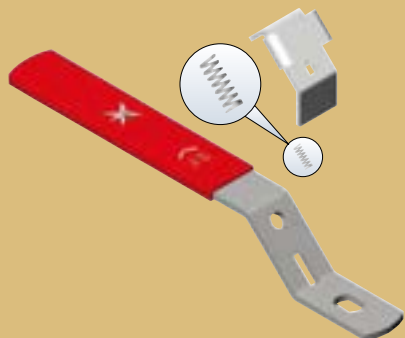

No matter the orientation of the ball valves, the SRSL handle always secures handle in position, make valve operation safe.

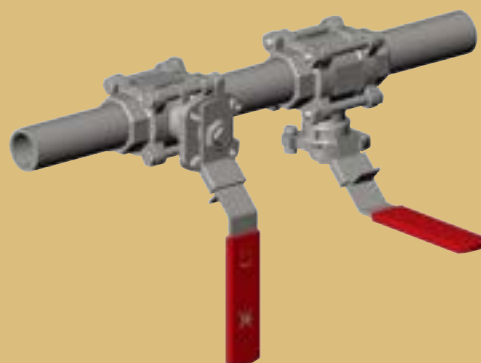

OVAL HANDLE



ECONOMICAL STEM EXTENSION

- 304 SS Construction
- Cost effective
- Easy installation





Warranty :

All Mars products are guaranteed against defects in manufacturing for a period of one year from the date of shipment, this warranty is limited to the products are used for the purpose for which they are manufactured and sold, the purchasers are expected to make their own judgment to determine the suitability of these products for their particular purpose. The fore-going is the only warranty and no other is expressed or implied.

CHANGE OF DESIGN :

We reserve the right to change designs, materials or specifications of any Mars product without prior notice, in due course of our manufacturing procedure, without incurring any obligation to accept for credit, to replace or furnish such changes or modification on products previously sold.



MARS VALVE CO., LTD. TRANSWORLD STEEL ENT. CO., LTD.

No. 83, Sec. 1, Chung De 8th Road, Taichung, 406, Taiwan R.O.C.
TEL: +886-4-2246-3808
FAX: +886-4-2247-0912
E-mail: mars@marsvalve.com.tw / sales@marsvalve.com.tw
www.marsvalve.com.tw

Distributed by:

